

DANE TECHNICZNE

Moc	aż 4 kW
Czas palenia	4,5 godziny
Objętość zbiorniku	3 litru
Paliwo	bioethanol
Ciężar biokominka	62 kg
Ciężar biokominka z opłaszczaniem	82 kg

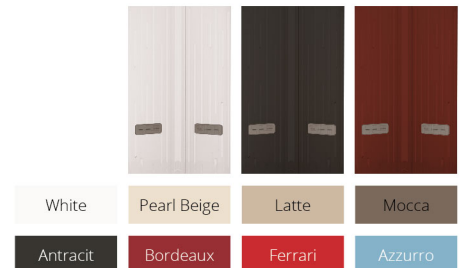

RYSUNEK TECHNICZNY

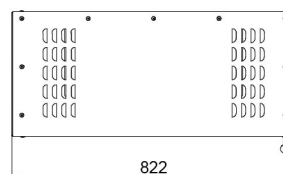
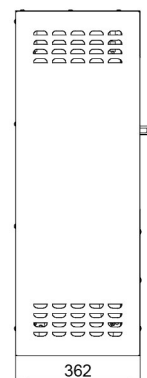
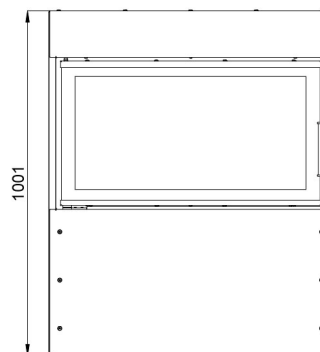
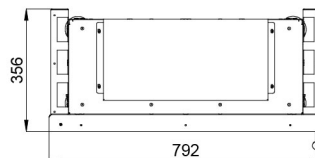
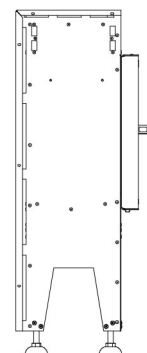
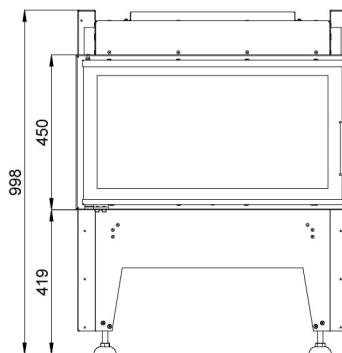

BEF SPIRIT 8

ČSN EN
13229